



S6

Multivoltage 50x50 mm compact sensors series

- 50x50 mm compact dimensions
- Free voltage Vac/Vdc models with relay output
- 10-30 Vdc model with transistor output
- Standard cable or M12 4-pole connection



SENSORS

APPLICATIONS

- Automatic machines
- Packaging lines
- Transportation lines
- Automatic warehouses



S6		
Through beam		0...20 m
Retroreflective (on R2 reflector)		0,1...6 m
Polarized retroreflective (on R2 reflector)		0,1...5 m
Diffuse proximity		10...900 mm
		10...2000 mm
		30...100 mm
Background suppression		30...250 mm
		100...500 mm
Power supply	Vdc	10...30 V
	Vac	
	Vac/dc	15...264 Vac/Vdc
Output	PNP	▪
	NPN	▪
	NPN/PNP	▪
	relay	▪
	other	
Connection	cable	▪
	connector	▪
	pig-tail	
Approximate dimensions (mm)		18x50x50
Housing material		ABS
Mechanical protection		IP65

TECHNICAL DATA	
Power supply	10 ... 30 Vdc limit values (mod. S6/S6T/S6R-5) 15 ... 264 Vac/Vdc (48 ... 60 Hz) limit values (mod. S6-1)
Ripple	2 Vpp max.
Consumption (output current excluded)	30 mA max. (mod. S6/S6T/S6R-5) 40 mA max. (mod. S6-1)
Light emission	IR LED 880 nm red LED 660 nm (mod. S6/S6R/S6T...B/M10)
Setting	sensitivity trimmer (excl. mod. S6...G, S6R-5-M) adjustment screw (mod. S6/S6T/S6R-5-M)
Operating mode	LIGHT/DARK selection by cable or connector (mod. S6/S6T/S6R-5) LIGHT/DARK selection by N.O./N.C. output (mod. S6R-5-M) LIGHT/DARK selection by trimmer (mod. S6-1)
Indicators	red OUTPUT LED (excl. mod. S6...G), POWER LED (mod. S6...G) green STABILITY LED (mod. S6-5-M25)
Output	NPN/PNP (mod. S6) PNP (mod. S6T) NPN or PNP; NC; NO (mod. S6R) Relay 1 NO and NC contact 250 Vac, 30 Vdc min. applicable load 5 Vdc, 10 mA (mod. S6-1)
Output current	100 mA max., 3 A max. (mod. S6-1)
Saturation voltage	1,5 V max. (NPN/PNP output)
Response time	1 ms max. 2 ms max. (mod. S6/S6R/S6T...F/G) 30 ms max. (mod. S6-1)
Switching frequency	500 Hz 250 Hz max. (mod. S6/S6R/S6T...F/G) 16 Hz (mod. S6-1)
Connection	2 m cable Ø 6 mm (mod. S6-1), 2 m cable Ø 5 mm (mod. S6-5), M12 4-pole connector (mod. S6T-S6R)
Dielectric strength	500 Vac, 1 min between electronics and housing
Insulating resistance	>20 MΩ, 500 Vdc between electronics and housing
Electrical protection	class 2, class 1 (mod. S6-1)
Mechanical protection	IP65
Ambient light rejection	according to EN 60947-5-2
Vibrations	0,5 mm amplitude, 10 ... 55 Hz frequency, for every axis (EN60068-2-6)
Shock resistance	11 ms (30 G) 6 shock for every axis (EN60068-2-27)
Housing material	ABS UL 94V-0
Lens material	PMMA plastic
Operating temperature	-25 ... 55 °C
Storage temperature	-25 ... 70 °C
Weight	160 g max. cable vers., 40 g max. conn. vers.

DIMENSIONS

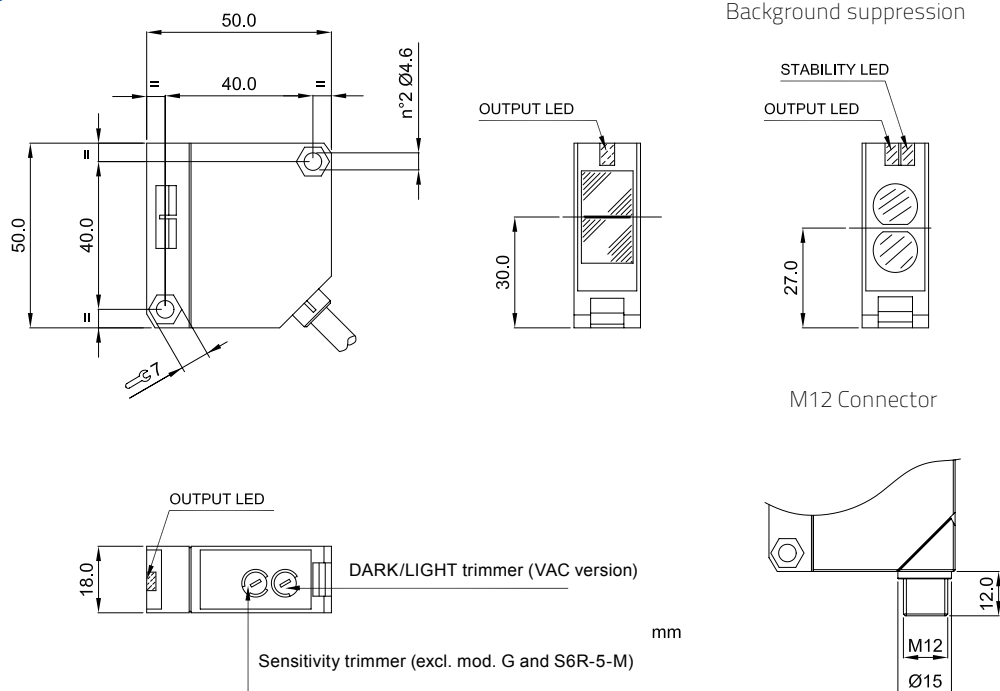

CONNECTIONS

VDC MODELS

NPN/PNP version

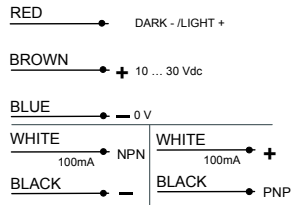

Through beam receiver - NPN/PNP version

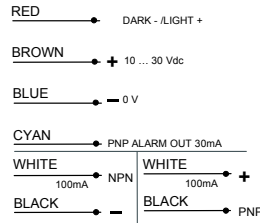

Through beam emitter - NPN/PNP version

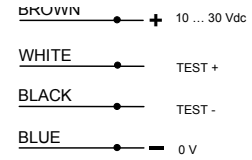

NPN or PNP and NC/NO version

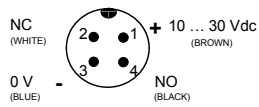

PNP version

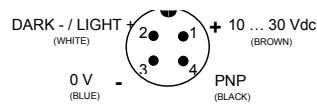

Through beam emitter - PNP version

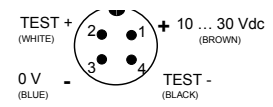

VAC MODELS

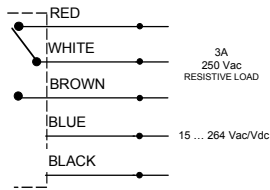

Through beam emitter



INDICATORS AND SETTINGS



Background suppression

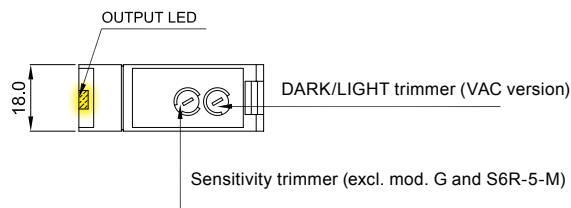
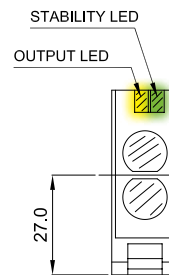
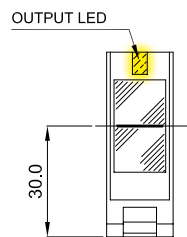

DETECTION DIAGRAMS

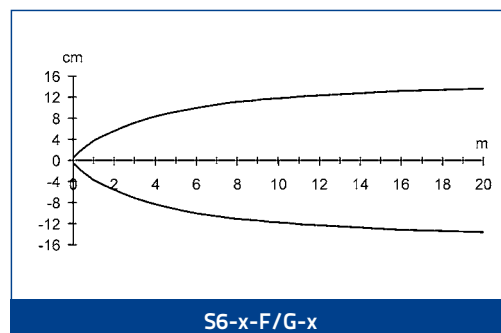
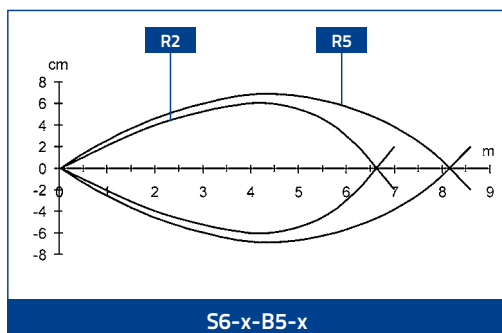
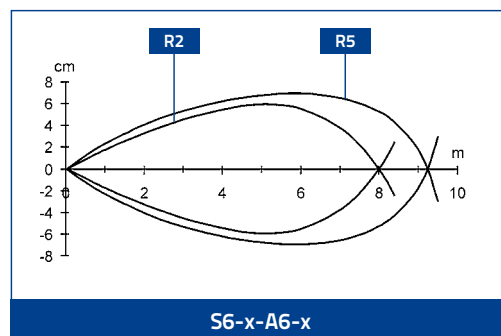
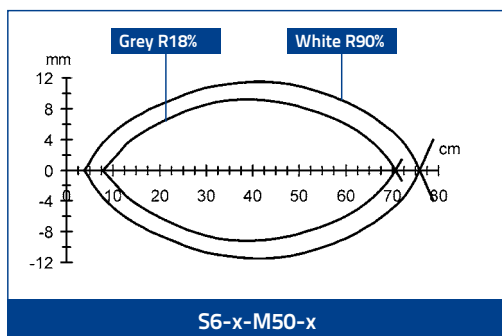
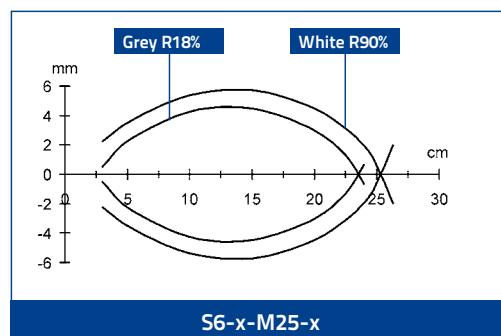
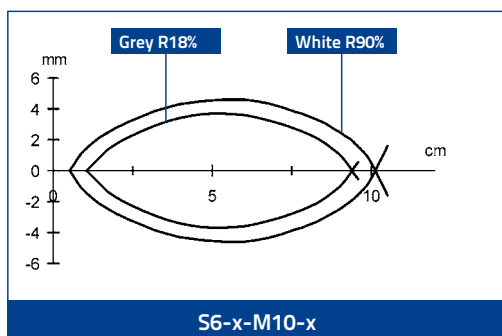
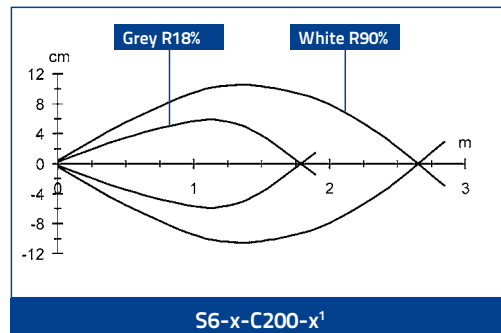
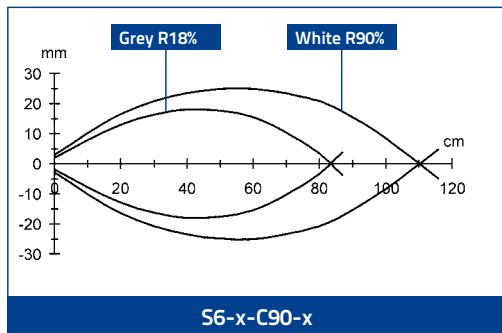

The detection diagrams indicate the typical operating distance with excess gain 1.

