

S65-Z SERIES

The **S65-Z** series offers a retroreflex line sensor for accurate measurements of the centre or edge position and width of objects. The detection is made on a reflecting tape, supplied with the sensor, positioned behind the object, with a 150 mm maximum measurement field width and a 200 mm operating distance. The 4-20 mA analogue output is proportional to the measurement, while the digital output, PNP or NPN according to the model, is activated when the measured value is included inside the interval fixed by the operator via teach-in. An alarm signal is activated when the luminous intensity received is weak. The setting is accomplished through three push-buttons present on the control panel, together with the output status LED, two LEDs signalling the operating mode, an alarm LED and a 4-digit display for the visualisation of the measurement and sensor configuration messages. Models with the RS485 serial interface offer the remote setting of all the programmable functions as well as the transmission of the measurements to an industrial PC are available.



MEASUREMENT

HIGHLIGHTS

- Line sensors with RS485 serial interface
- PNP or NPN digital output and 4 - 20 mA analogue output
- Teach-in of the measurement limit values for digital output activation
- 3 setting push-buttons and a 4-digit display

APPLICATIONS

Automatic machines



Pharmaceuticals

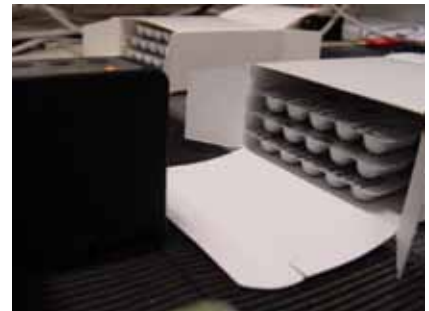

Packaging lines



The object to measure is illuminated by the infrared emission cone. The light reflected by the reflector is detected by a photodiode array and analysed according to 3 operating modes:

- Edge position: detects the position of the right or left edge of an object or of the first edge beginning from the right or left side in presence of more objects;
- Centre position: detects the centre independently from the object's dimensions;
- Width measurement: in presence of one object it provides the distance between two edges; in presence of different objects it provides the sum of the respective widths;

The analogue output generates a signal proportional to the distance from the reference edge or to the object width; the digital output switches when the detected position or measurement is inside the interval acquired via teach-in.

DIMENSIONS

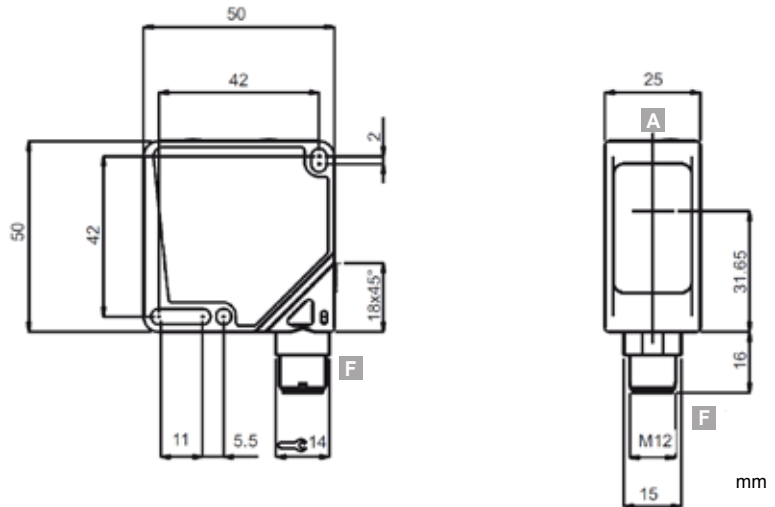

INDICATORS AND SETTING

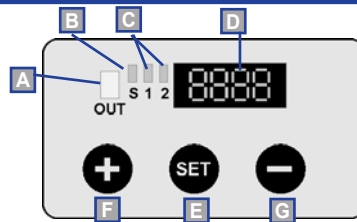

- A Output status LED
- B Alarm LED
- C Operating mode LEDs
- D 4-digit display
- E SET push-button
- F +/- selection push-buttons
- G M12 connector output orientable on two positions

ACCESSORIES

For **dedicated accessories** refer to the **ACCESSORIES** section of this catalogue.

Refer also to **Connectors** and **Fixing Brackets** and **Supports** of the **General Catalogue**.

CONNECTIONS

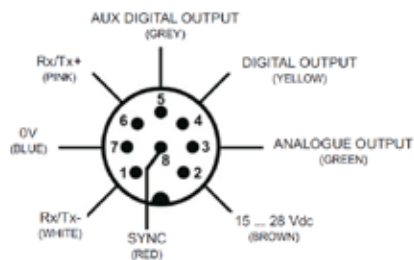

Versions and options: refer to **MODEL SELECTION TABLE**

TECHNICAL DATA

TECHNICAL NOTES

- ¹Limit values
- ²Average life of 100.000 h with T_A = +25 °C
- ³Connector can be blocked on two positions
- ⁴A - reverse polarity protection
- B - overload and short-circuit protection

		S65-PA-5-Z03-NNI	S65-PA-5-Z03-NNIZ	S65-PA-5-Z03-PPI	S65-PA-5-Z03-PPIZ
Measurement distance from object:	200 mm	•	•	•	•
Measured width:	150 mm	•	•	•	•
Power supply:	10 ... 30 Vdc ¹	•	•	•	•
Ripple:	2 Vpp	•	•	•	•
Consumption:	< 70 mA	•	•	•	•
Light emission ²:	infrared LED 875 nm	•	•	•	•
Minimum dimension measured:	0.9 mm	•	•	•	•
Resolution:	0.15 mm	•	•	•	•
Linearity error:	≤ 1%	•	•	•	•
Setting:	3 push-buttons	•	•	•	•
Indicators:	4-digit display	•	•	•	•
	2 green operating mode LEDs	•	•	•	•
	green ALARM LED	•	•	•	•
	yellow OUTPUT LED	•	•	•	•
Output type:	PNP, NA	•	•	•	•
	NPN, NA	•	•		
	analogue 4-20 mA	•	•	•	•
Output current:	≤ 100 mA at 25°C	•	•	•	•
Saturation voltage:	≤ 1.2 V	•	•	•	•
Switching frequency:	> 130 Hz	•	•	•	•
Auxiliary functions:	RS485 serial interface	•	•	•	•
	keylock	•	•	•	•
	delay	•	•	•	•
Connection:	M12 8-pole connector ³	•	•	•	•
Electrical protection:	class 2	•	•	•	•
Mechanical protection	IP67	•	•	•	•
Protection devices:	A, B ⁴	•	•	•	•
Housing material:	ABS	•	•	•	•
Lens material:	glass	•	•	•	•
Weight:	100 g max.	•	•	•	•
Operating temperature	-10 ... +55°C	•	•	•	•
Storage temperature:	-20 ... +70°C	•	•	•	•
Standard reference:	EN 60947-5-2	•	•	•	•

SELECTION TABLE

models with RS485 serial interface			
S65-PA-5-Z03-NNIZ	956251070	NPN	
S65-PA-5-Z03-PPIZ	956251060	PNP	RS485
models without RS485 serial interface			
S65-PA-5-Z03-NNI	956251050	NPN	RS485
S65-PA-5-Z03-PPI	956251040	PNP	



DETECTION DIAGRAMS

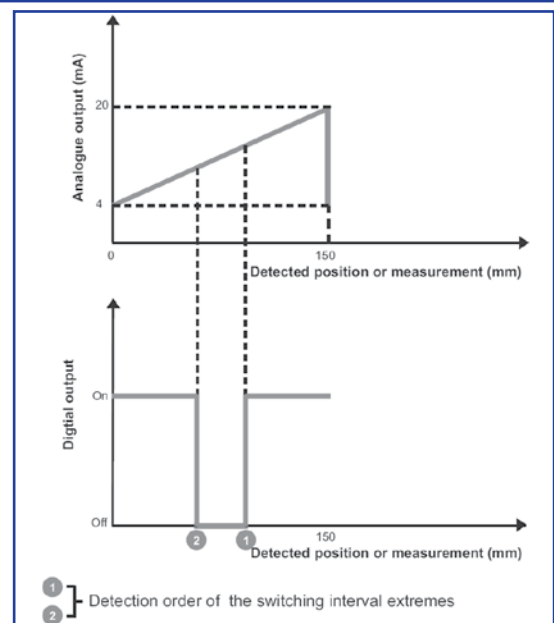
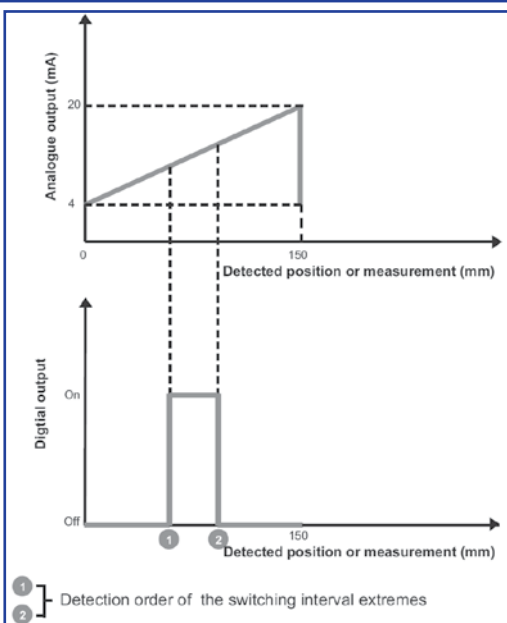

Note: the digital output is activated inside the switching range if the inferior limit is acquired first and then the superior limit. The inverse logic functioning is obtained inverting the acquisition order.

MODEL SELECTION AND ORDER INFORMATION

MODEL	RS485	CONNECTION	OUTPUT	ORDER N°
S65-PA-5-Z03-NNI		M12 connector	NPN	956251050
S65-PA-5-Z03-NNIZ	•	M12 connector	NPN	956251070
S65-PA-5-Z03-PPI		M12 connector	PNP	956251040
S65-PA-5-Z03-PPIZ	•	M12 connector	PNP	956251060

ACCESSORY DIMENSIONS

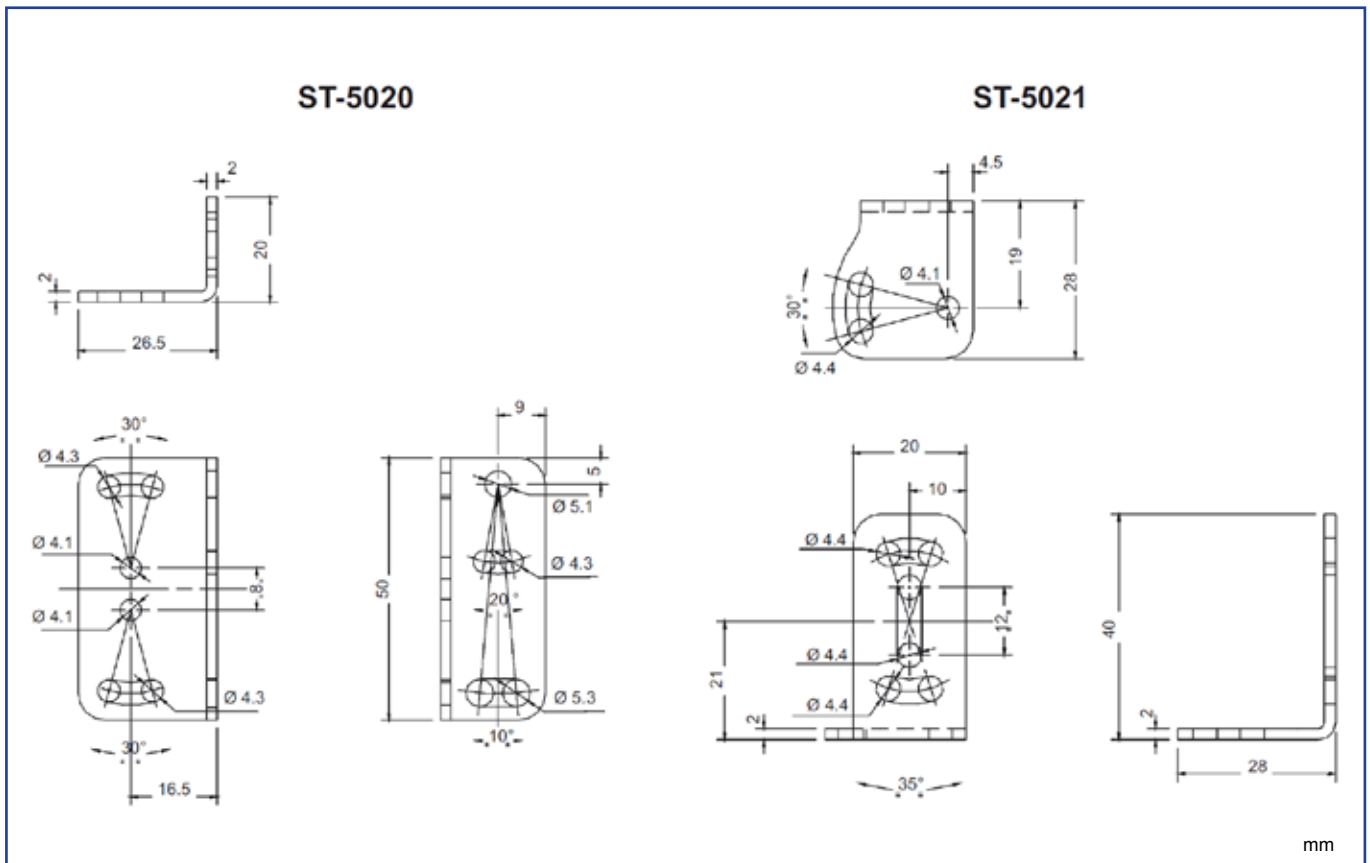

ACCESSORY SELECTION AND ORDER INFORMATION

MODEL	DESCRIPTION	ORDER N°
ST-5020	fixing bracket 50 x 27 x 20 mm	95ACC5330
ST-5021	fixing bracket 20 x 40 x 28 mm	95ACC5340
TAPE S65-Z	self-adhesive reflective tape 25 x 900 mm	95ACC2290
S65-Z REFLECTOR	20x175 mm reflector with 47x190 mm support	95ACC2390
Refer also to Accessories for Sensors		
CS-A1-06-B-03	M12 8-pole unshielded axial 3 m connector	95ACC2230
CS-A1-06-B-05	M12 8-pole unshielded axial 5 m connector	95ACC2240
CS-A1-06-B-10	M12 8-pole unshielded axial 10 m connector	95ACC2250

The company endeavours to continuously improve and renew its products; for this reason the technical data and contents of this catalogue may undergo variations without prior notice. For correct installation and use, the company can guarantee only the data indicated in the instruction manual supplied with the products.